

# Moulding Selection Guide

2006

PRICE \$5.00

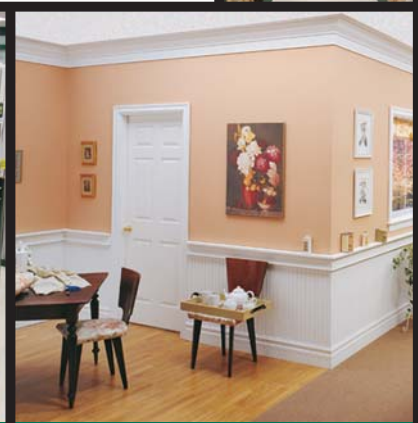
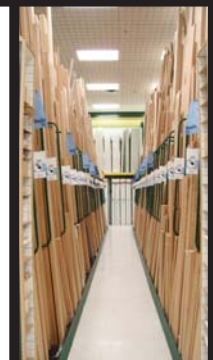

*It takes a Great Start...  
...to have a Great Finish*

**MOULDING & MILLWORK**

# MOULDING & MILLWORK

## CROSS REFERENCE INDEX CHART



### MOULDING & MILLWORK

#### CASINGS

D101 Casing	MP3000
D102 Casing	MP3002
D103 Casing	MP356/MFPU356
D104 Casing	MP356WM/MFPU356WM
D105 Casing	MP3004
D111 Casing	MP3005
D112 Casing	MP1208
D113 Casing	MP3121/MFPU3121
D114 Casing	MP1207
D115 Casing	MFPU251
D116 Casing	MFPU411
D117 Casing	MFPU411A
D118 Casing	MFPU3122
D119 Casing	MFPU9038
D120 Casing	MFPU410
D123 Casing	MFPU908
D124 Casing	MFPU907
D131 Casing	MFPU8233
D133 Casing	MP444
D138 Casing	MFPU003
D139 Casing	MFPU139
D141 Casing	MFPU415
D144 Casing	MFPU8063
D151 Casing	MFPU535
1/2" x 2-1/2" Casing	MFPU492
5/8" x 2-1/2" Casing	MFPU472
1/2" x 3-1/4" Casing	MFPU494

#### BASEBOARDS

D201 Baseboard	MP625
D202 Baseboard	MP623/MFPU623
D203 Baseboard	MP618/MFPU618
D221 Baseboard	MP653
D222 Baseboard	MP663
D223 Baseboard	MP673
D225 Baseboard	MFPU8910
D226 Baseboard	MFPU9243
D231 Baseboard	MP309/MFPU309
D232 Baseboard	MP310/MFPU310
D233 Baseboard	MP311/MFPU311
D236 Baseboard	MFPU545
D238 Baseboard	MFPU8234
D241 Baseboard	MFPU205W
D242 Baseboard	MFPU205T
D243 Baseboard	MFPU206
D244 Baseboard	MFPU207
D245 Baseboard	MFPU161
D246 Baseboard	MFPU163
D247 Baseboard	MFPU8243
D251 Baseboard	MP3140
D257 Baseboard	MP3112
D261 Baseboard	MFPU412
D262 Baseboard	MFPU414
D267 Baseboard	MFPU9753
D268 Baseboard	MFPU750
D295 Baseboard	MFPU8263



### MOULDING & MILLWORK

#### CROWNS

D311 Crown	MP54
D312 Crown	MP51/MFPU51
D313 Crown	MP47/MFPU47
D314 Crown	MFPU43
D315 Crown	MFPU512
D321 Crown	MP40
D322 Crown	MFPU40
D323 Crown	MFPU41
D324 Crown	MFPU443
D325 Crown	MFPU445
D326 Crown	MFPU47D
D341 Crown	MP3242
D342 Crown	MP3244
D343 Crown	MP3248
D350 Crown	MP409/MFPU409
D351 Crown	MFPU509
D352 Crown	MFPU168
D353 Crown	MFPU242

#### WINDOW STOOL

D3410 Window Stool	MP3410
D3411 Window Stool	MP3411
D3412 Window Stool	MP3412
D3413 Window Stool	MP3413

#### PANEL MOULDS, CHAIR RAILS, & ARCHITRAVES

D410 Chair Rail	MP297/MFPU297
D412 Panel Mould	MP182
D421 Panel Mould	MFPU184
D900 Architrave	MFPU5000
D907 Architrave	MFPU5010
D908 Architrave	MFPU5030
D909 Architrave	MFPU5020

#### BATTENS

D422 Batten	MP3277
D243 Batten	MP3279
D424 Batten	MP3278

#### WAINSCOT, PANELLING, & CAPS

D413 Wainscot	MP980
D425 Wainscot	MP292
D427 Panel Cap	MP3724

[www.DICKSLUMBER.com](http://www.DICKSLUMBER.com)

#### BURNABY LOCATION

2580 Gilmore Avenue  
Burnaby, British Columbia  
Canada V5C 4T5  
Tel: 604-437-1111  
Fax: 604-437-1910

#### NORTH VANCOUVER LOCATION

160 Hanes Avenue  
North Vancouver, British Columbia  
Canada V7P 2L8  
Tel: 604-987-4444  
Fax: 604-987-4406

#### SURREY LOCATION

12433 80th Avenue  
Surrey, British Columbia  
Canada V3W 3A4  
Tel: 604-591-1222  
Fax: 604-591-1236

**Casings**

Casings define the overall character of a room and are often the most visible part of the trim. They are used primarily to cover the gap between drywall and the door or window frame. Casings are generally thicker than the base mouldings.

**ALL SIZES NOMINAL**



<b>3000</b>		<b>BDL</b>
7/16" x 1-7/16" - 14'	FJ Primed	30
1/2" x 1-1/2" - RL	Hemlock	20



<b>3002</b>		<b>BDL</b>
3/8" x 2-3/16" - 14'	FJ Primed	20
1/2" x 2-1/4" - RL	Hemlock	10



<b>3004</b>		<b>BDL</b>
3/8" x 2-3/16" - RL	Hemlock	10
13/32" x 2-3/16" - 14'	FJ Primed	20



<b>8233</b>		<b>BDL</b>
15mm x 3-1/4" - 15'	Ultralite	10



<b>003</b>		<b>BDL</b>
5/8" x 3-1/4" - RL	Hemlock	6
18mm x 3-1/4" - 15'	Ultralite	6



<b>3121</b>		<b>BDL</b>
15mm x 2-3/4" - 15'	Ultralite	10



<b>3122</b>		<b>BDL</b>
25mm x 3-1/2" - 15'	Ultralite	8

**Casings**

Casings define the overall character of a room and are often the most visible part of the trim. They are used primarily to cover the gap between drywall and the door or window frame. Casings are generally thicker than the base mouldings.

**ALL SIZES NOMINAL**

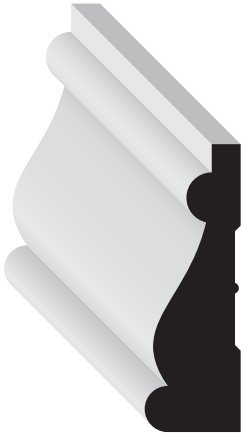

<b>3005</b>	<b>BDL</b>
1/2" x 1-1/2" - 14'	FJ Primed 30



<b>1208</b>	<b>BDL</b>
5/8" x 2-7/16" - 14'	FJ Primed 12
16mm x 2-1/2" - 14'	MDF Primed 6
11/16" x 2-1/2" - RL	Hemlock 10



<b>1207</b>	<b>BDL</b>
11/16" x 2-5/8" - 14'	FJ Primed 12



<b>3126</b>	<b>BDL</b>
1" x 3-1/8" - 15'	Ultralite 8



<b>356</b>	<b>BDL</b>
7/16" x 2-1/8" - RL	Knotty Pine 12
1/2" x 2-1/8" - RL	Oak 10
9mm x 2-1/4" - 14'	MDF Primed 10
3/8" x 2-1/4" - 14'	FJ Primed 20
12mm x 2-1/4" - 14'	Ultralite 16



<b>356 WM</b>	<b>BDL</b>
15mm x 2-1/4" - 14'	Ultralite 6
5/8" x 2-1/4" - RL	Hemlock 10
11/16" x 2-1/4" - 14'	FJ Primed 12



<b>444</b>	<b>BDL</b>
7/16" x 3-1/8" - 15'	FJ Primed 10



<b>251</b>	<b>BDL</b>
18mm x 3-1/4" - 15'	Ultralite 6

<b>357</b>	<b>BDL</b>
7/16" x 2-1/8" - RL	Hemlock 6

**Casings**

Casings define the overall character of a room and are often the most visible part of the trim. They are used primarily to cover the gap between drywall and the door or window frame. Casings are generally thicker than the base mouldings.

**ALL SIZES NOMINAL**



<b>410</b>	<b>BDL</b>
18mm x 2-1/4" - 14'	Ultralite 8



<b>411A</b>	<b>BDL</b>
18mm x 2-3/4" - 15'	Ultralite 8



<b>411</b>	<b>BDL</b>
3/4" x 3" - RL	Hemlock 6
18mm x 3" - 15'	Ultralite 6



<b>8063</b>	<b>BDL</b>
18mm x 3-1/4" - 15'	Ultralite 6



<b>535</b>	<b>BDL</b>
11/16" x 3-1/2" - RL	Hemlock 6
18mm x 3-1/2" - 15'	Ultralite 6



<b>139</b>	<b>BDL</b>
30mm x 3-3/4" - 15'	Ultralite 4

**Casings**

Casings define the overall character of a room and are often the most visible part of the trim. They are used primarily to cover the gap between drywall and the door or window frame. Casings are generally thicker than the base mouldings.

**ALL SIZES NOMINAL**



<b>9038</b>	<b>BDL</b>
11/16" x 4-1/2" - 14'	Ultralite 6

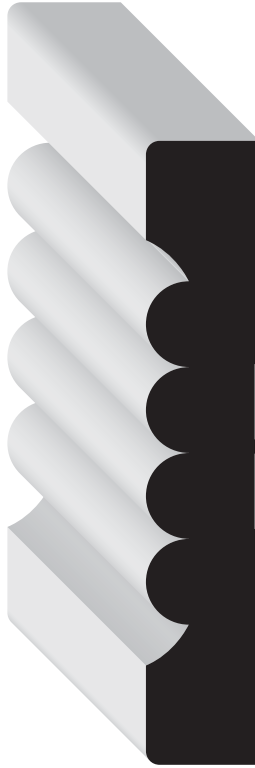

<b>908</b>	<b>BDL</b>
15mm x 3-1/4" - 14'	Ultralite 7

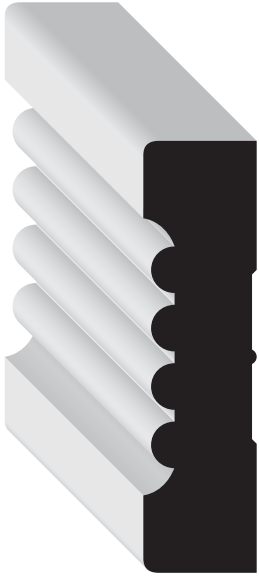

<b>907</b>	<b>BDL</b>
15mm x 2-1/4" - 14'	Ultralite 10

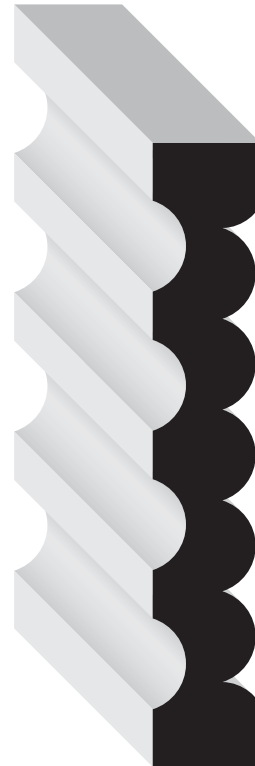

<b>3125</b>	<b>BDL</b>
9/16" x 3-1/4" - 15'	FJ Primed 10
9/16" x 3-1/4" - 15'	Oak 10



<b>3130</b>	<b>BDL</b>
9/16" x 2-1/4" - 14'	FJ Primed 10



<b>415</b>	<b>BDL</b>
15mm x 2-1/4" - 14'	Ultralite 12

**E2E Profiles**

E2E (Eased 2 Edges) profiles are available in additional widths and thicknesses upon request.

**ALL SIZES NOMINAL**

<b>494</b>	<b>BDL</b>
12mm x 3-1/4" - 16'	Ultralite 10



<b>492</b>	<b>BDL</b>
12mm x 2-1/2" - 14'	Ultralite 10



<b>472</b>	<b>BDL</b>
15mm x 2-1/2" - 14'	Ultralite 10

<b>473</b>	<b>BDL</b>
5/8" x 2-1/4" - 14'	Hemlock 10



<b>434</b>	<b>BDL</b>
5/8" x 3-1/4" - 16'	Hemlock 10



<b>496</b>	<b>BDL</b>
1/2" x 3-1/2" - 16'	MDF Primed 10



<b>497</b>	<b>BDL</b>
1/2" x 4-1/2" - 16'	MDF Primed 10



<b>498</b>	<b>BDL</b>
1/2" x 5-1/2" - 16'	MDF Primed 10

## Architraves

In classical architecture, it described the main beam resting on the tops of the columns. Today it is often used as a decorative moulding for ornamentation or finishing at the top of windows and doors.

**ALL SIZES NOMINAL**

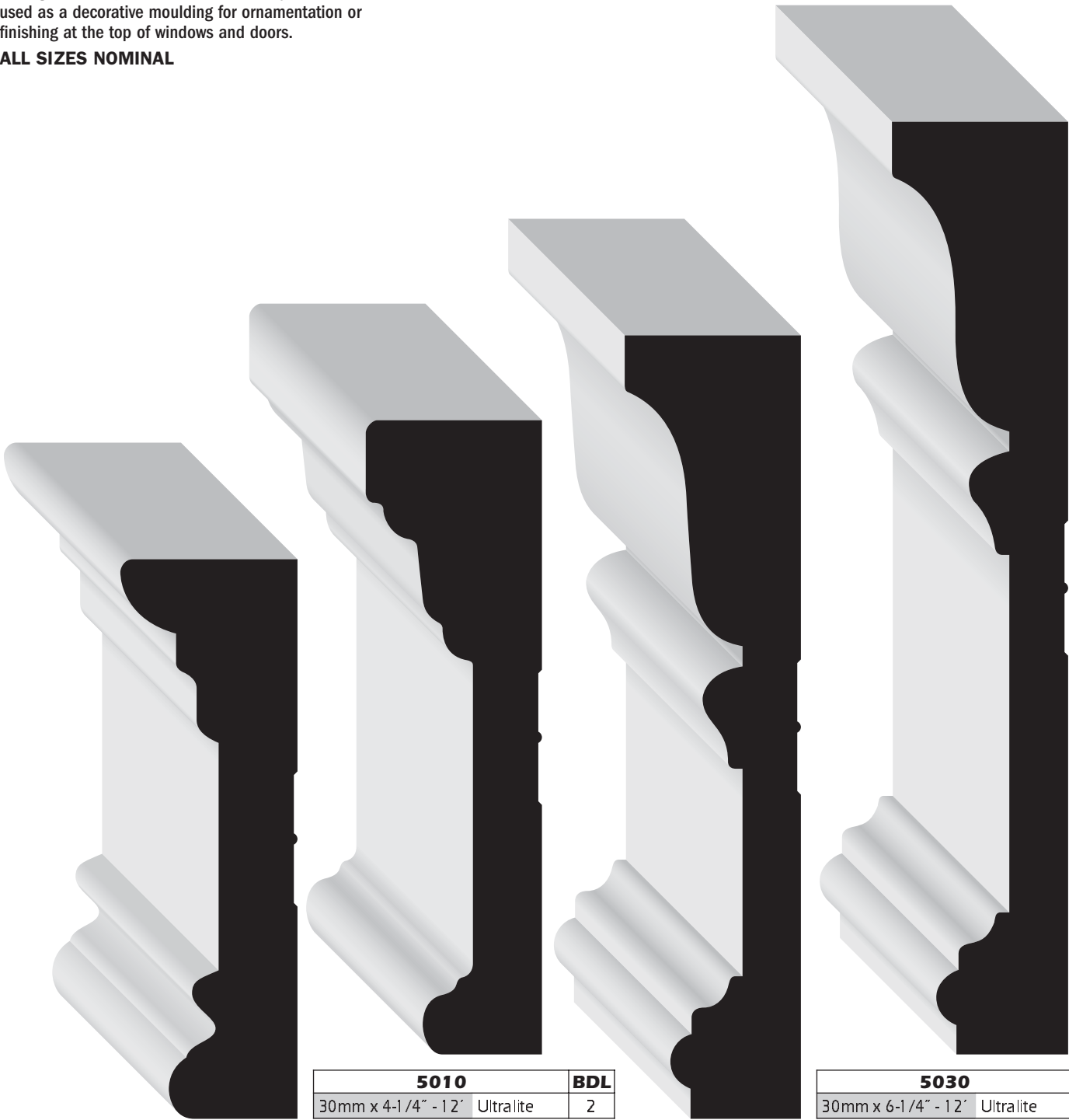

<b>5000</b>		<b>BDL</b>
30mm x 3-3/4" - 12'	Ultralite	4
1-3/16" x 3-3/4" - RL	Hemlock	4

<b>5010</b>		<b>BDL</b>
30mm x 4-1/4" - 12'	Ultralite	2

<b>5020</b>		<b>BDL</b>
30mm x 5-1/4" - 12'	Ultralite	2

<b>5030</b>		<b>BDL</b>
30mm x 6-1/4" - 12'	Ultralite	2

## Baseboards

Baseboards are placed along the wall at the floor. They should be chosen to work in harmony with your casings to finish and tie the room together. Baseboards are usually thinner than the casing.

**ALL SIZES NOMINAL**



<b>3120</b>		<b>BDL</b>
9/16" x 2-1/4" - 16'	Hemlock	10



<b>3112</b>		<b>BDL</b>
7/16" x 3-1/4" - RL	Hemlock	10
7/16" x 3-1/4" - 16'	FJ Primed	10



<b>625</b>		<b>BDL</b>
7/16" x 2-1/4" - 16'	FJ Primed	20



<b>623</b>		<b>BDL</b>
7/16" x 3-1/4" - RL	Hemlock	10
7/16" x 3-1/4" - 16'	FJ Primed	10
12mm x 3-1/4" - 16'	Ultralite	9



<b>8243</b>		<b>BDL</b>
12mm x 4-1/4" - 16'	Ultralite	6



<b>8234</b>		<b>BDL</b>
15mm x 5-1/2" - 16'	Ultralite	4



<b>618</b>		<b>BDL</b>
1/2" x 5-3/16" - 16'	FJ Primed	6
15mm x 5-1/4" - 16'	Ultralite	4

## Baseboards

Baseboards are placed along the wall at the floor. They should be chosen to work in harmony with your casings to finish and tie the room together. Baseboards are usually thinner than the casing.

**ALL SIZES NOMINAL**

<b>309</b>		<b>BDL</b>
5/8" x 3-1/4" - 16'	Ultralite	6
11/16" x 3-1/4" - 16'	FJ Primed	6

<b>310</b>		<b>BDL</b>
5/8" x 4-1/8" - 16'	Ultralite	6
11/16" x 4-1/8" - 16'	FJ Primed	6

<b>311</b>		<b>BDL</b>
5/8" x 5-1/4" - 16'	Ultralite	6
11/16" x 5-1/4" - 16'	FJ Primed	6



<b>653</b>		<b>BDL</b>
9mm x 3-1/4" - 14'	MDF Primed	10
1/2" x 3-1/4" - RL	Hemlock	10
1/2" x 3-1/4" - RL	Oak	10

<b>663</b>		<b>BDL</b>
12mm x 4-3/16" - 14'	MDF Primed	8
1/2" x 4-1/4" - RL	Hemlock	10
9/16" x 4-1/4" - 16'	FJ Primed	8

<b>673</b>		<b>BDL</b>
1/2" x 5-1/4" - 16'	FJ Primed	6

**Baseboards**

Baseboards are placed along the wall at the floor. They should be chosen to work in harmony with your casings and tie the room together. Baseboards are usually thinner than the casing.

**ALL SIZES NOMINAL**



<b>3140</b>		<b>BDL</b>
7/16" x 3-3/16" - 16'	FJ Primed	10
9mm x 3-1/4" - 14'	MDF Primed	10
3/8" x 3-1/4" - RL	Knotty Pine	10
3/8" x 3-1/4" - RL	Oak	10



<b>8910</b>		<b>BDL</b>
9mm x 3-7/8" - 16'	Ultralite	12



<b>205W</b>		<b>BDL</b>
15mm x 4-1/8" - 16'	Ultralite	6



<b>205T</b>		<b>BDL</b>
12mm x 3-7/8" - 16'	Ultralite	6

<b>441</b>		<b>BDL</b>
1" x 4-1/2" - 16'	Ultralite	4



**Baseboards**

Baseboards are placed along the wall at the floor. They should be chosen to work in harmony with your casings to finish and tie the room together. Baseboards are usually thinner than the casing.

**ALL SIZES NOMINAL**

<b>9753</b>	<b>BDL</b>
1 1/16" x 4-1/2" - 16'	Ultralite 6



<b>750</b>	<b>BDL</b>
1 1/16" x 5-1/2" - 16'	Ultralite 4



<b>206</b>	<b>BDL</b>
15mm x 5-1/4" - 16'	Ultralite 4



<b>207</b>	<b>BDL</b>
15mm x 7-1/4" - 16'	Ultralite 4

## Baseboards

Baseboards are placed along the wall at the floor. They should be chosen to work in harmony with your casings to finish and tie the room together. Baseboards are usually thinner than the casing.

**ALL SIZES NOMINAL**

<b>412</b>		<b>BDL</b>
9/16" x 4-1/4" - RL	Hemlock	6
15mm x 4-1/4" - 16'	Ultralite	6

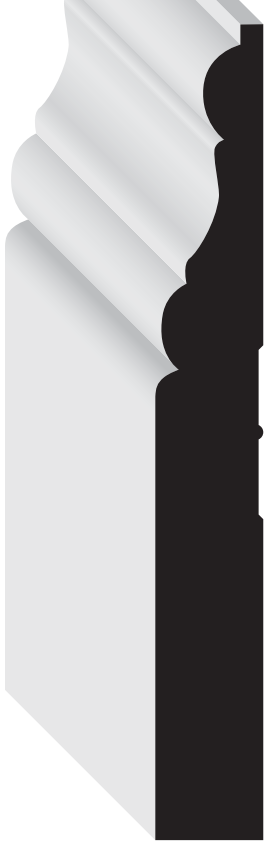

<b>8263</b>		<b>BDL</b>
15mm x 6-1/2" - 16'	Ultralite	3

<b>414</b>		<b>BDL</b>
15mm x 5-1/4" - 16'	Ultralite	4



<b>9263</b>		<b>BDL</b>
11/16" x 7-1/16" - 16'	Ultralite	3

<b>9243</b>		<b>BDL</b>
5/8" x 5-1/4" - 16'	Ultralite	4



## Baseboards & Base Shoes

Baseboards are placed along the wall at the floor. They should be chosen to work in harmony with your casings to finish and tie the room together. Baseboards are usually thinner than the casing.

Base Shoes are primarily used to trim flooring materials and are often used in combination with a traditional baseboard to conceal variations between the flooring and the base. This versatile profile works great to solve numerous trimming needs.

**ALL SIZES NOMINAL**



<b>545</b>		<b>BDL</b>
9/16" x 5" - RL	Hemlock	4
15mm x 5" - 16'	Ultralite	4



<b>161</b>		<b>BDL</b>
15mm x 5-1/4" - 16'	Ultralite	4



<b>163</b>		<b>BDL</b>
15mm x 7-1/4" - 16'	Ultralite	6



<b>3288</b>		<b>BDL</b>
1/2" x 3/4" - RL	Hemlock	25



<b>3290</b>		<b>BDL</b>
1/2" x 3/4" - RL	Hemlock	25
1/2" x 3/4" - 16'	FJ Primed	25

## Crowns

Crowns are placed along the wall at the ceiling. They come in a wide range of patterns and sizes. Crowns soften the transition from wall to ceiling while adding a distinctive look and charm to your room.

**ALL SIZES NOMINAL**

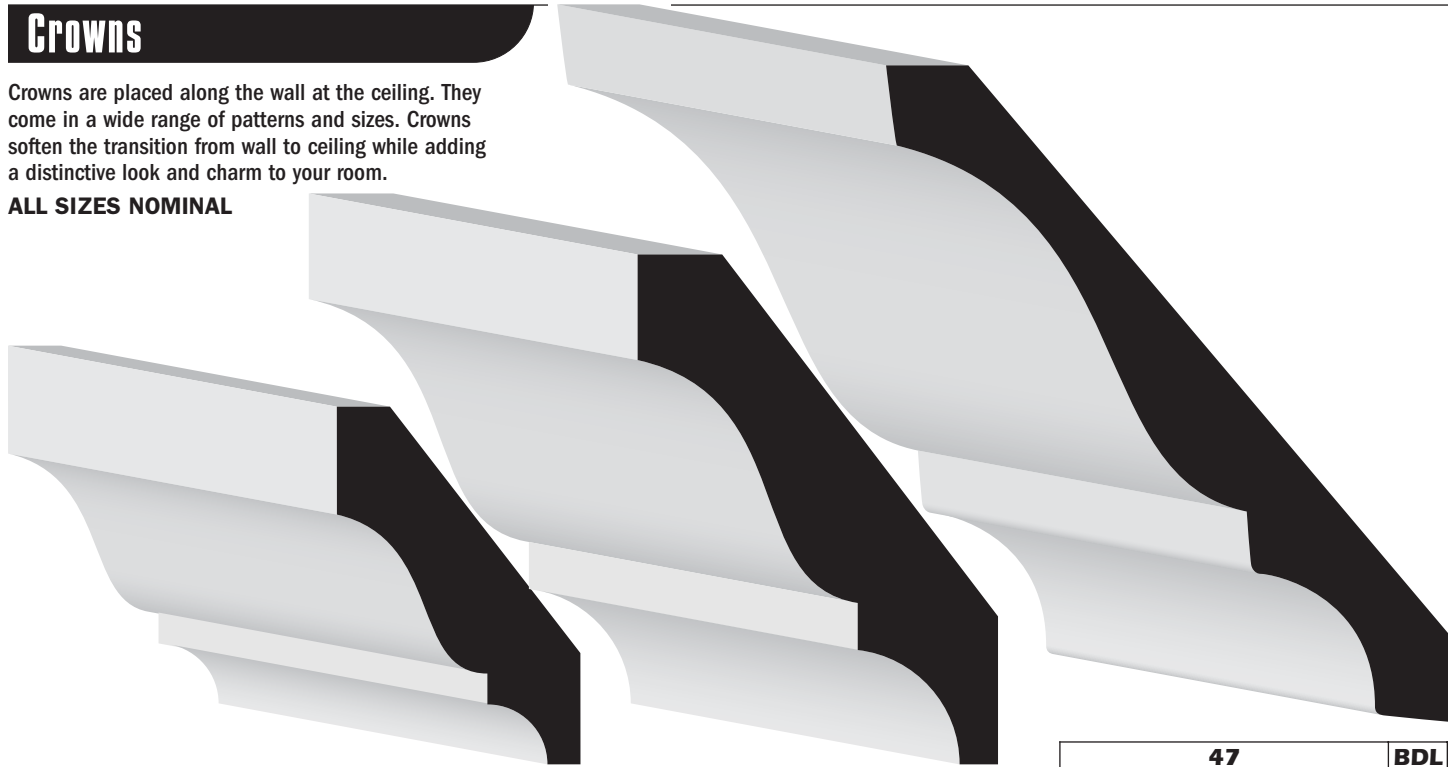

<b>54</b>	<b>BDL</b>
9/16" x 2-1/4" - 16'	FJ Primed 12

<b>51</b>	<b>BDL</b>
9/16" x 3-1/4" - 16'	FJ Primed 8
15mm x 3-1/4" - 16'	Ultralite 5
11/16" x 3-1/4" - RL	Oak 6

<b>47</b>	<b>BDL</b>
15mm x 4-1/4" - 16'	FJ Primed 8
9/16" x 4-1/2" - 16'	Ultralite 6

<b>48</b>	<b>BDL</b>
1/2" x 4-3/16" - RL	Hemlock KOH

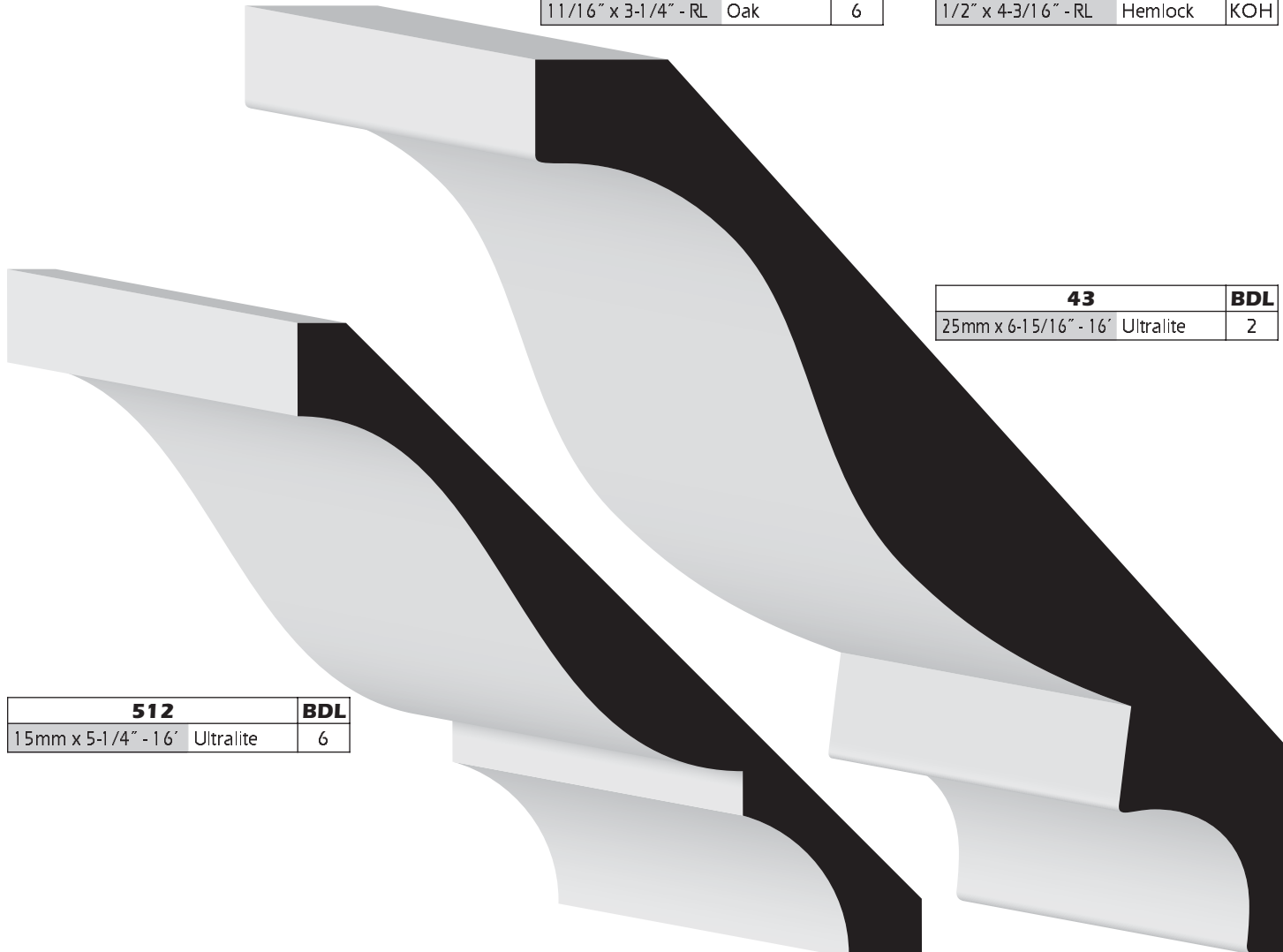

<b>43</b>	<b>BDL</b>
25mm x 6-15/16" - 16'	Ultralite 2

<b>512</b>	<b>BDL</b>
15mm x 5-1/4" - 16'	Ultralite 6

## Crowns

Crowns are placed along the wall at the ceiling. They come in a wide range of patterns and sizes. Crowns soften the transition from wall to ceiling while adding a distinctive look and charm to your room.

**ALL SIZES NOMINAL**

<b>40</b>	<b>BDL</b>
18mm x 4-1/4" - 16'	Ultralite 2

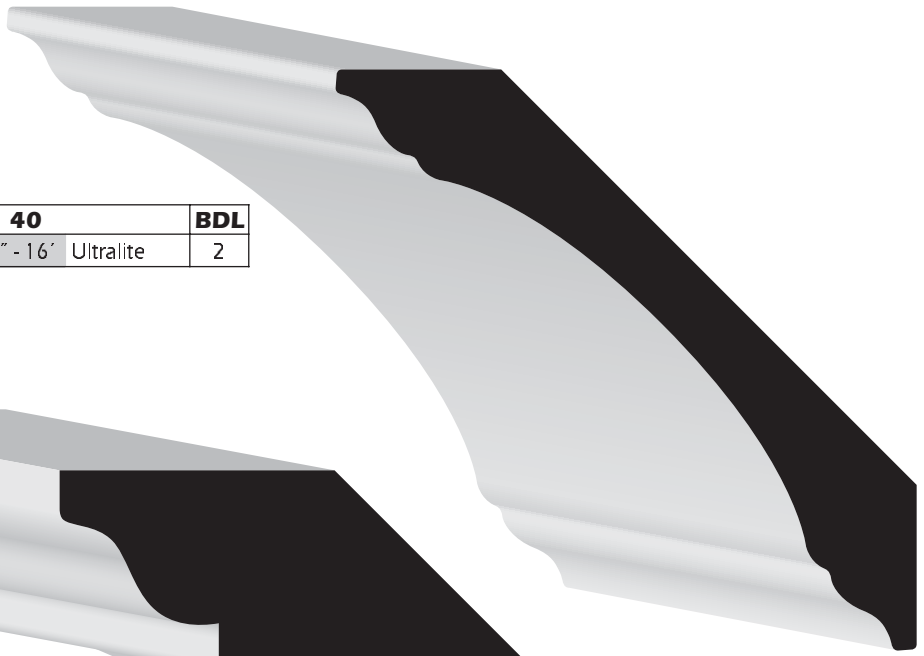

<b>41</b>	<b>BDL</b>
30mm x 6-5/16" - 16'	Ultralite 2



<b>513</b>	<b>BDL</b>
1" x 7-1/4" - 16'	Ultralite 2

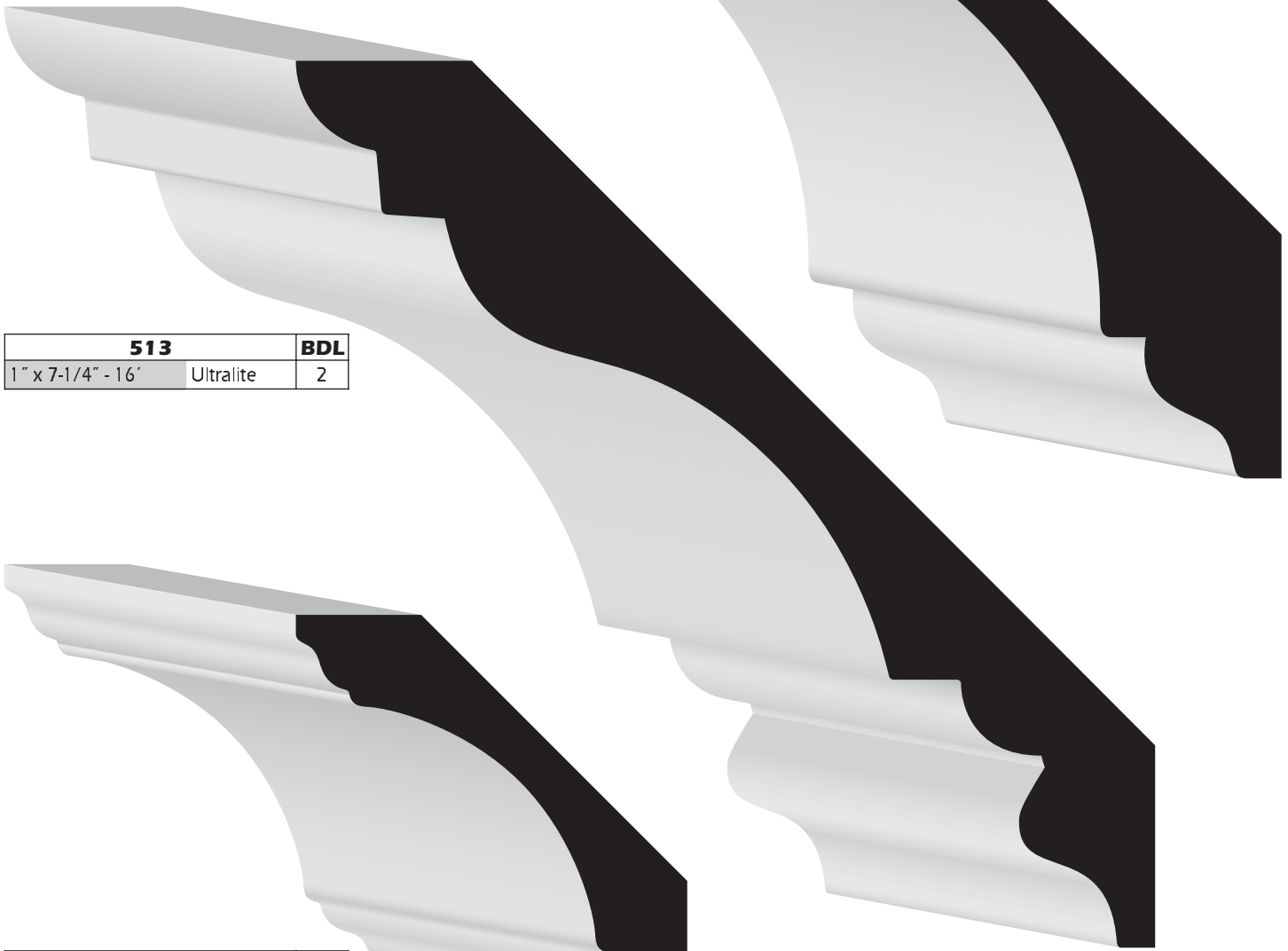

<b>Cornice 40</b>	<b>BDL</b>
21/32" x 3-1/4" - 16'	FJ Primed 6

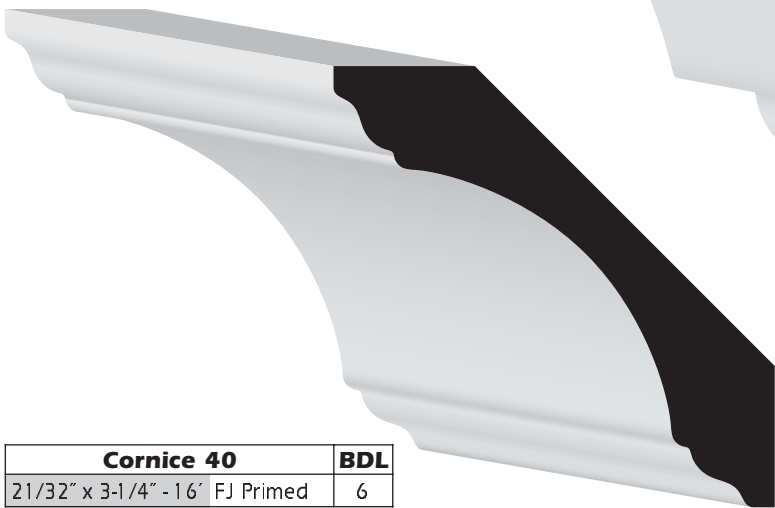

## Crowns

Crowns are placed along the wall at the ceiling. They come in a wide range of patterns and sizes. Crowns soften the transition from wall to ceiling while adding a distinctive look and charm to your room.

**ALL SIZES NOMINAL**

<b>712</b>	<b>BDL</b>
5/8" x 4-1/2" - 16'	Ultralite 2

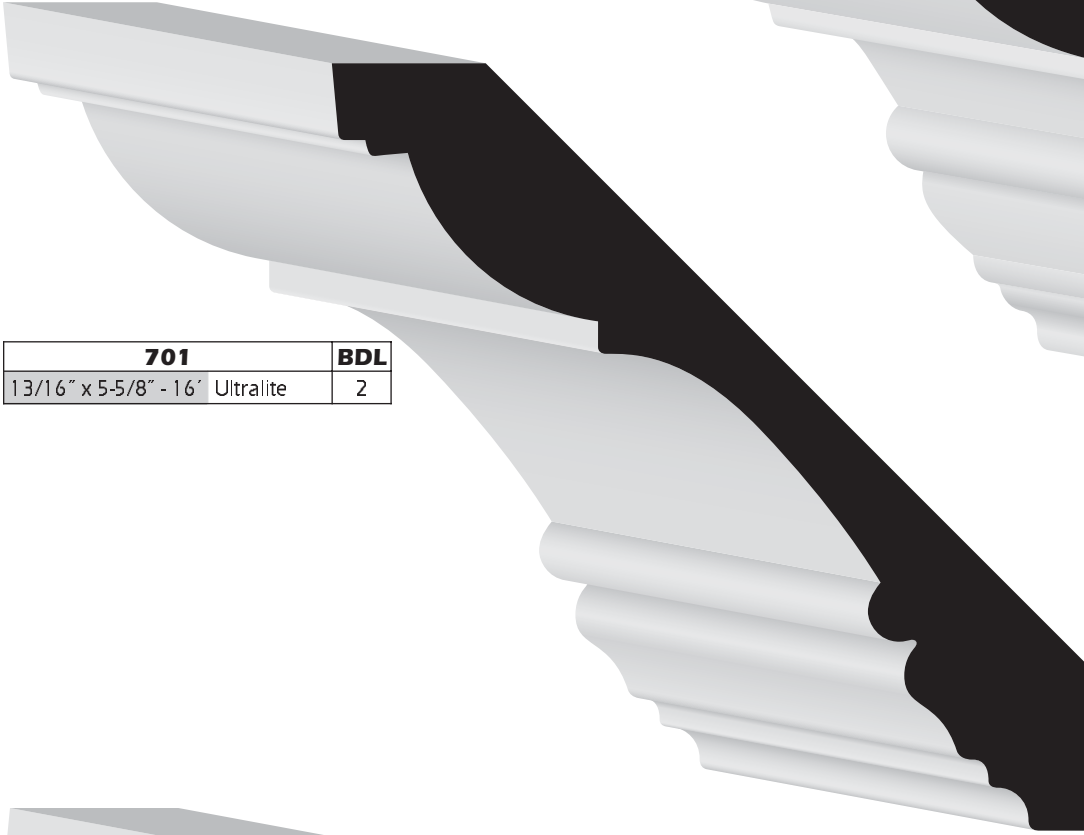

<b>701</b>	<b>BDL</b>
13/16" x 5-5/8" - 16'	Ultralite 2



<b>445</b>	<b>BDL</b>
30mm x 5" - 16'	Ultralite 2

<b>443</b>	<b>BDL</b>
25mm x 3-9/16" - 16'	Ultralite 4

## Crowns

Crowns are placed along the wall at the ceiling. They come in a wide range of patterns and sizes. Crowns soften the transition from wall to ceiling while adding a distinctive look and charm to your room.

**ALL SIZES NOMINAL**

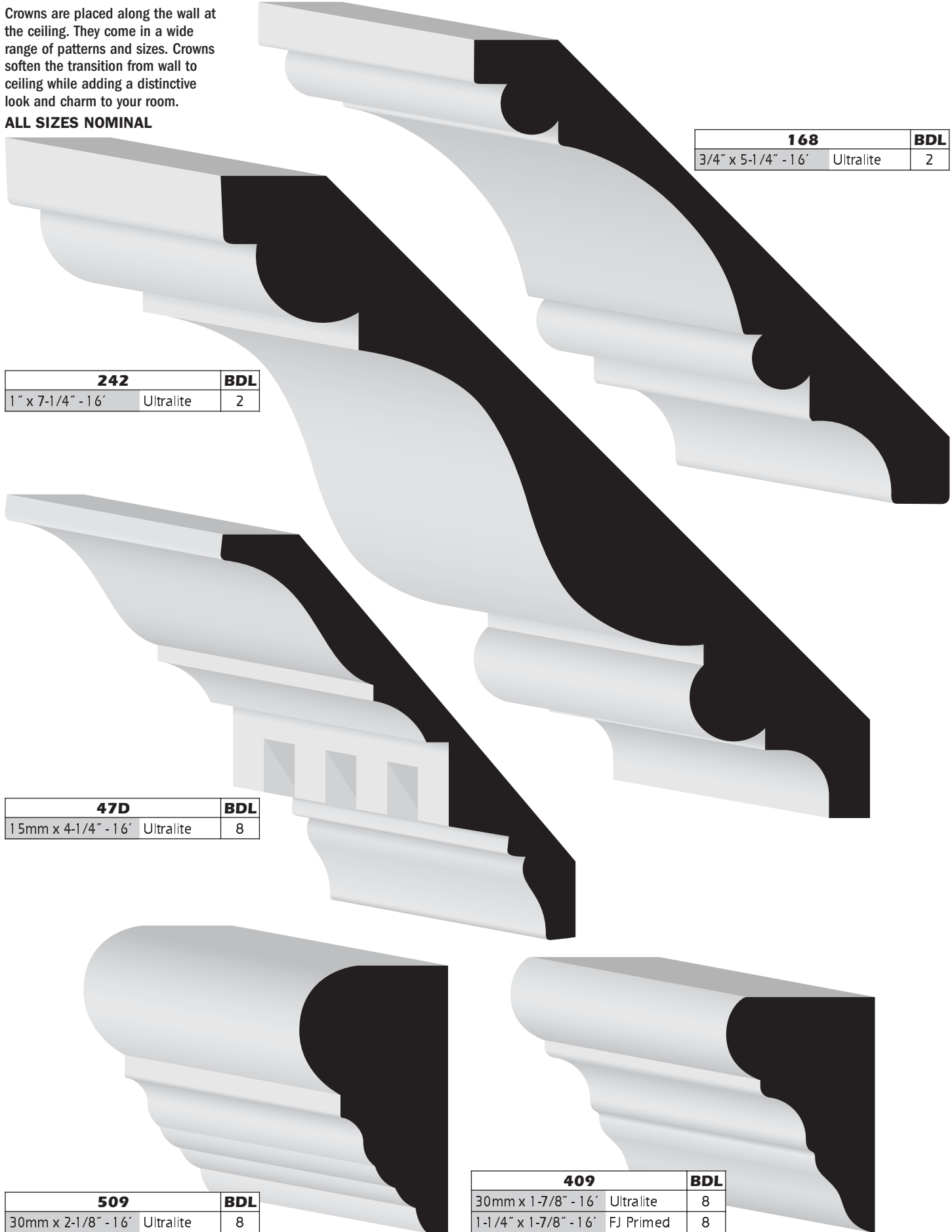

<b>168</b>	<b>BDL</b>
3/4" x 5-1/4" - 16'	Ultralite 2

<b>242</b>	<b>BDL</b>
1" x 7-1/4" - 16'	Ultralite 2

<b>47D</b>	<b>BDL</b>
15mm x 4-1/4" - 16'	Ultralite 8

<b>509</b>	<b>BDL</b>
30mm x 2-1/8" - 16'	Ultralite 8

<b>409</b>	<b>BDL</b>
30mm x 1-7/8" - 16'	Ultralite 8
1-1/4" x 1-7/8" - 16'	FJ Primed 8

## Crowns

Crowns are placed along the wall at the ceiling. They come in a wide range of patterns and sizes. Crowns soften the transition from wall to ceiling while adding a distinctive look and charm to your room.

**ALL SIZES NOMINAL**

3240		BDL
3/8" x 1/2" - RL	Hemlock	25
3/8" x 9/16" - 8'	FJ Primed	25

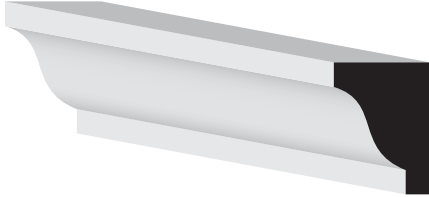

3242		BDL
7/16" x 11/16" - RL	Oak	20
1/2" x 11/16" - RL	Hemlock	25
1/2" x 11/16" - 14'	FJ Primed	25



3244		BDL
9/16" x 1-1/4" - 14'	FJ Primed	24
5/8" x 1-1/4" - RL	Hemlock	24
5/8" x 1-1/4" - RL	Oak	20



3248		BDL
1-3/16" x 2-1/4" - RL	Hemlock	4
1-3/16" x 2-1/4" - 16'	FJ Primed	8

## Coves

Coves are commonly used to soften the transition on inside corners but may be used for a wide range of applications.

**ALL SIZES NOMINAL**

3264		BDL
11/16" x 11/16" - RL	Hemlock	25
11/16" x 11/16" - RL	Oak	20
11/16" x 11/16" - 8' & 14'	FJ Primed	30

334		BDL
1/2" x 1-1/2" - RL	Hemlock	20

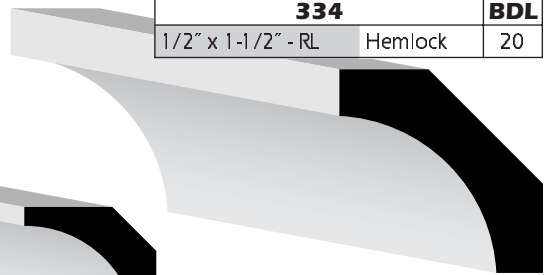

3260		BDL
1/2" x 1/2" - RL	Hemlock	25
1/2" x 1/2" - 8'	FJ Primed	40



## Chair Rails

Chair Rails are practical as well as decorative. Applied to a wall, from 24 to 48 inches up from the floor, they protect the wall from scuffs and dents from the backs of chairs as well as adding a distinctive accent to any room.

**ALL SIZES NOMINAL**



980		BDL
7/16" x 2-1/4" - 14'	FJ Primed	16



297		BDL
9/16" x 3" - RL	Oak	6
5/8" x 3" - RL	Hemlock	6
11/16" x 3" - 14'	FJ Primed	8
18mm x 3" - 16'	Ultralite	6

## Panel Moulds

Panel Moulds are used to frame wall paneling and add an accent to your walls. Often used in furniture construction.

**ALL SIZES NOMINAL**



<b>182</b>	<b>BDL</b>
9/16" x 1-9/16" - 14' FJ Primed	20



<b>184</b>	<b>BDL</b>
18mm x 1-1/2" - 14' Ultralite	20



<b>292</b>	<b>BDL</b>
9/16" x 1-1/8" - 14' FJ Primed	20



<b>101</b>	<b>BDL</b>
7/16" x 15/16" - RL Hemlock	25

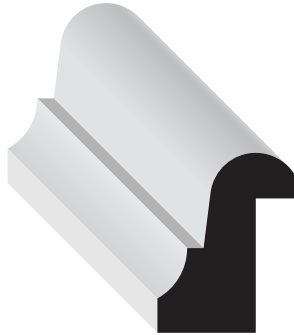

<b>3721</b>	<b>BDL</b>
3/4" x 15/16" - RL Oak	20

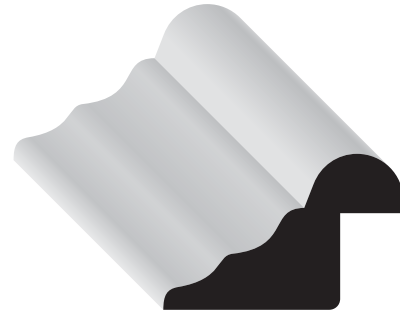

<b>3724</b>	<b>BDL</b>
3/4" x 1-1/8" - 14' FJ Primed	20
13/16" x 1-1/4" - RL Oak	20

## Door Stops, Battens, & Screen Moulds

The Door Stop mouldings are attached to the door jamb on both sides and at the top. It is where the door comes to a rest when it is closed stopping the door from moving any further, and covering the gap that would otherwise appear between the door and the jambs.

A Batten is a narrow strip of wood used to cover joints or as decorative vertical members over plywood or wide boards.

A very versatile profile; Screen Mould fits a wide variety of needs and uses. Traditionally used to hold mesh screening into wood screens, it also works well as edge trim on various shelving or wood trim for wall finishes.

**ALL SIZES NOMINAL**



<b>3422</b>	<b>BDL</b>
3/8" x 1-3/16" - RL Hemlock	30
3/8" x 1-3/16" - RL Oak	20
3/8" x 1-1/4" - 14' FJ Primed	30



<b>0010</b>	<b>BDL</b>
3/8" x 1-5/8" - RL Hemlock	20
<b>3294</b>	<b>BDL</b>
3/8" x 1-5/8" - RL Oak	20
3/8" x 1-5/8" - 14' FJ Primed	20



<b>0001</b>	<b>BDL</b>
7/16" x 2-1/4" - RL Hemlock	10
<b>3296</b>	<b>BDL</b>
5/16" x 2-1/4" - RL Oak	10
3/8" x 2-1/4" - 14' FJ Primed	20

**Door Stops, Battens & Screen Moulds**

The Door Stop mouldings are attached to the door jamb on both sides and at the top. It is where the door comes to a rest when it is closed stopping the door from moving any further, and covering the gap that would otherwise appear between the door and the jambs.

A Batten is a narrow strip of wood used to cover joints or as decorative vertical members over plywood or wide boards.

A very versatile profile; Screen Mould fits a wide variety of needs and uses. Traditionally used to hold mesh screening into wood screens, it also works well as edge trim on various shelving or wood trim for wall finishes.

**ALL SIZES NOMINAL**

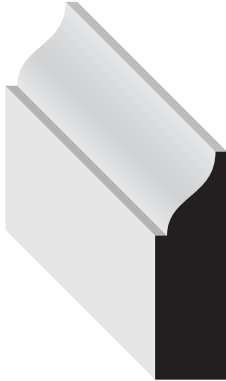

<b>936</b>	<b>BDL</b>
3/8" x 1-1/4" - 14'	FJ Primed 30

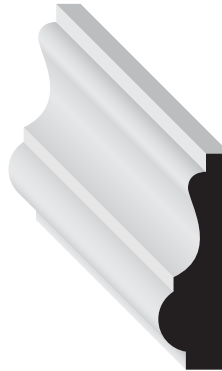

<b>3278</b>	<b>BDL</b>
3/8" x 1-1/8" - 14'	FJ Primed 30



<b>3279</b>	<b>BDL</b>
7/16" x 1-5/8" - 14'	FJ Primed 20



<b>3274</b>	<b>BDL</b>
1/4" x 3/4" - RL	Hemlock 50
1/4" x 3/4" - RL	Oak 30
1/4" x 3/4" - 8'	FJ Primed 40

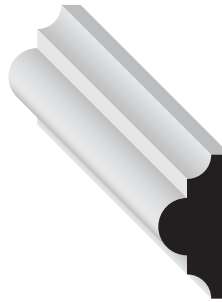

<b>3277</b>	<b>BDL</b>
3/8" x 3/4" - 14'	FJ Primed 30

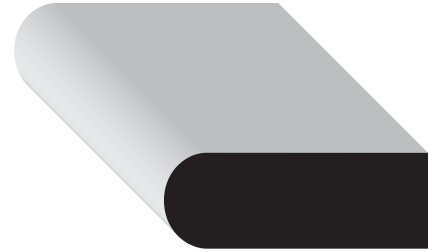

<b>9532</b>	<b>BDL</b>
1/2" x 1-3/8" - 10'	MDF Primed 25

**Handrails**

Handrails provide safety and support.

**ALL SIZES NOMINAL**

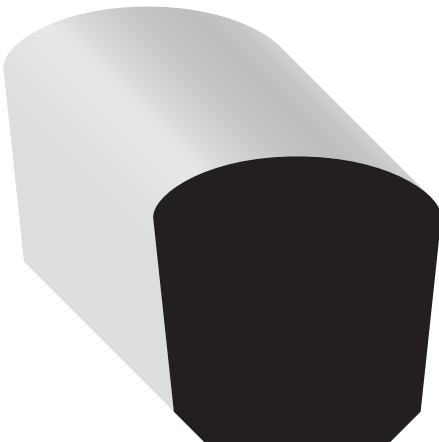

<b>3510</b>	<b>BDL</b>
1-1/2" x 1-1/2" - RL	Hemlock 6

<b>S201</b>	<b>BDL</b>
3/8" x 1-5/8" - RL	Hemlock 10



<b>S202</b>	<b>BDL</b>
1 5/16" x 3-1/8" - RL	Hemlock pcs
1-1/4" x 3-1/8" - RL	Hemlock pcs

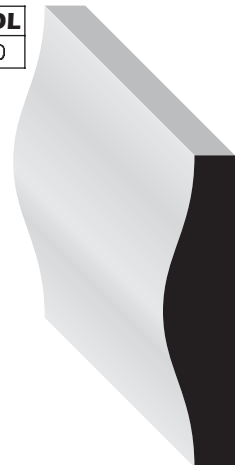

## Handrails

Handrails provide safety and support while going up or down stairs.

**ALL SIZES NOMINAL**

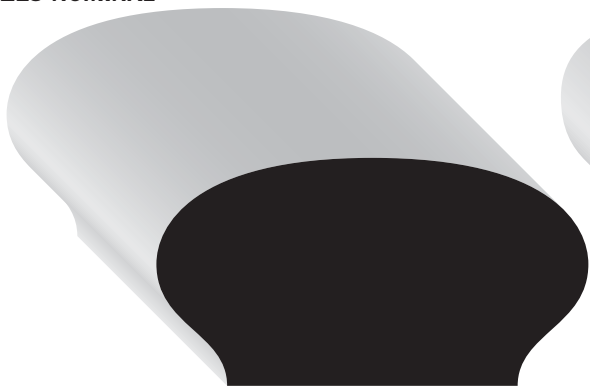

<b>3507</b>	<b>BDL</b>
1-3/16" x 2-1/4" - RL Hemlock	4



<b>S200</b>	<b>BDL</b>
1-1/4" x 3-1/16" - RL Hemlock	pcs

## Brickmoulds

A Brickmould is used as exterior casing around doors. 2 inches is the most common size, however, 1-1/2 and 1-1/4 inch sizes are available.

**ALL SIZES NOMINAL**



<b>303</b>	<b>BDL</b>
1-3/16" x 1-3/8" - 7' & 14' FJ Primed	8
1-1/4" x 1-1/2" - RL Hemlock	6



<b>180</b>	<b>BDL</b>
1-3/16" x 2" - 7' & 14' FJ Primed	8



<b>3322</b>	<b>BDL</b>
1-3/16" x 1-15/16" - RL Hemlock	4
1-3/16" x 2" - 14' FJ Primed	6

## Corners & Squares

Corners are used to protect the outside edges of the wall from damage and abrasion. Corners come in a wide variety of sizes and detailing.

Squares and Parting Beads are used in a wide range of applications including filling gaps and transitioning heights. This profile may also be used in a variety of craft projects.

**ALL SIZES NOMINAL**



<b>3516</b>	<b>BDL</b>
1 1/16" x 1 1/16" - 14' FJ Primed	30

<b>3517</b>	<b>BDL</b>
1-1/16" x 1-1/16" - RL Hemlock	9

<b>3520</b>	<b>BDL</b>
1 1/16" x 1 1/16" - RL Hemlock	25



<b>3428</b>	<b>BDL</b>
1/2" x 3/4" - 14' FJ Primed	30

<b>3429</b>	<b>BDL</b>
1/2" x 3/4" - RL Hemlock	25

## Corners & Squares

Corners are used to protect the outside edges of the wall from damage and abrasion. Corners come in a wide variety of sizes and detailing.

Squares and Parting Beads are used in a wide range of applications including filling gaps and transitioning heights. This profile may also be used in a variety of craft projects.

**ALL SIZES NOMINAL**



<b>3282</b>		<b>BDL</b>
1 1/16" x 1 1/16" - RL	Hemlock	25
1 1/16" x 1 1/16" - 8'	FJ Primed	30
3/4" x 3/4" - 8'	Oak	20

<b>3280</b>		<b>BDL</b>
1-1/16" x 1-1/16" - RL	Hemlock	20
1-1/16" x 1-1/16" - 8'	Oak	20
1-1/16" x 1-1/16" - 8'	FJ Primed	30

<b>202</b>		<b>BDL</b>
1-1/8" x 1-1/8" - 8'	Oak	20
1-1/8" x 1-1/8" - 8'	FJ Primed	30

## Quarter, Half & Full Rounds

Quarter Rounds come in several sizes and serve a variety of functions. They are most often used to finish inside corners.

A cross section of a Half Round looks like a half circle and is used primarily as decorative trim. It works well as a trim piece for wall paper or to add a decorative pattern to flat panels. This profile can also be used to put a rounded edge on various shelving.

Full Rounds are used for numerous purposes and projects. Some of the more common uses are closet poles, curtain rods and towel rods.

**ALL SIZES NOMINAL**

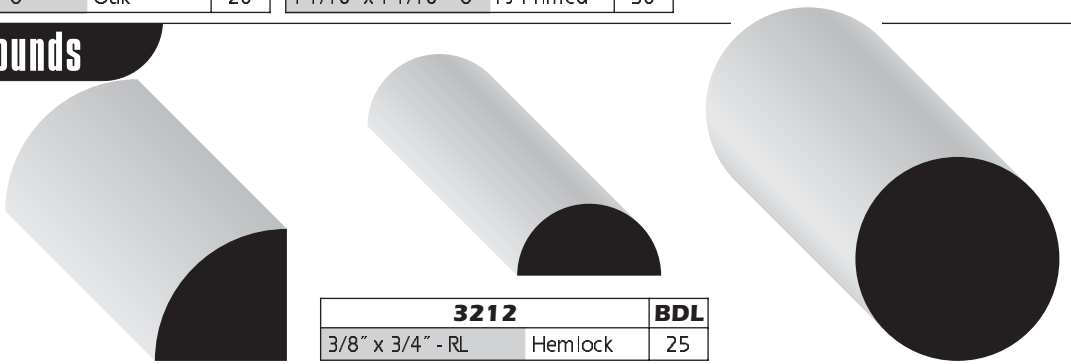

<b>3212</b>		<b>BDL</b>
3/8" x 3/4" - RL	Hemlock	25

<b>3200</b>		<b>BDL</b>
1/4" x 1/4" - RL	Hemlock	25

<b>3202</b>		<b>BDL</b>
1/2" x 1/2" - RL	Hemlock	25
1/2" x 1/2" - RL	Oak	20
1/2" x 1/2" - 8'	FJ Primed	30

<b>3206</b>		<b>BDL</b>
1 1/16" x 1 1/16" - RL	Hemlock	25
1 1/16" x 1 1/16" - RL	Oak	20
1 1/16" x 1 1/16" - 8'	FJ Primed	30

<b>3220</b>		<b>BDL</b>
1/2" - RL	Hemlock	25

<b>3222</b>		<b>BDL</b>
1 1/16" - RL	Hemlock	25

<b>3224</b>		<b>BDL</b>
1-1/16" - RL	Hemlock	10

<b>3226</b>		<b>BDL</b>
1-5/16" - RL	Hemlock	10

<b>3228</b>		<b>BDL</b>
1-1/2" - RL	Hemlock	10

## Wainscot

Trimwork installed in the area below a chair rail. Numerous options are available including raised panel, shadow box and beaded. Combined with a chair rail and baseboard, Wainscoting creates a dramatic look to any room.

**ALL SIZES NOMINAL**

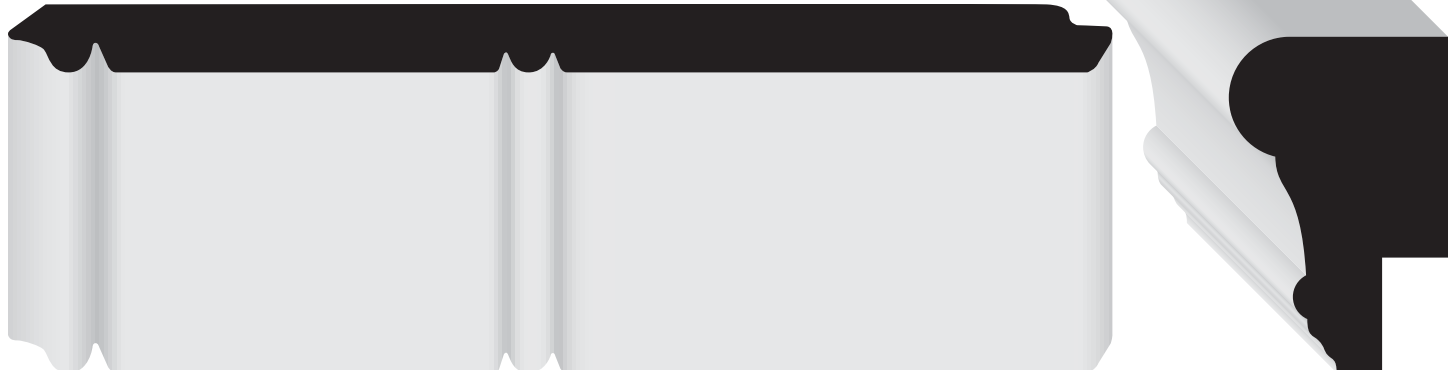

<b>222</b>		<b>BDL</b>
9mm x 5-3/4" - 10'	MDF Primed	pcs

<b>850</b>		<b>BDL</b>
29mm x 1-3/4" - 8'	MDF Primed	4

## Window Stool

Also called window sill, a Window Stool is the surface installed below the sash of a window. Trim installed under window stool creates a distinctive look and adds a decorative touch.

**ALL SIZES NOMINAL**

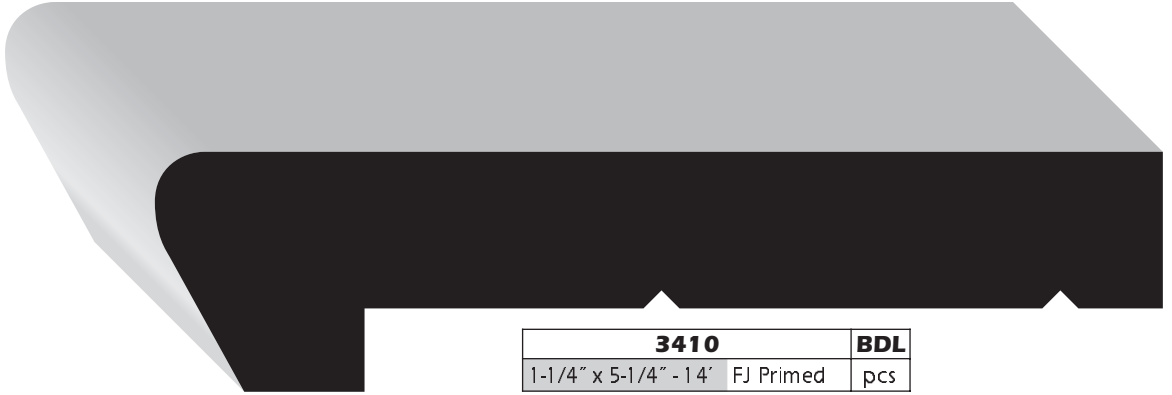

<b>3410</b>	<b>BDL</b>
1-1/4" x 5-1/4" - 14'	FJ Primed pcs

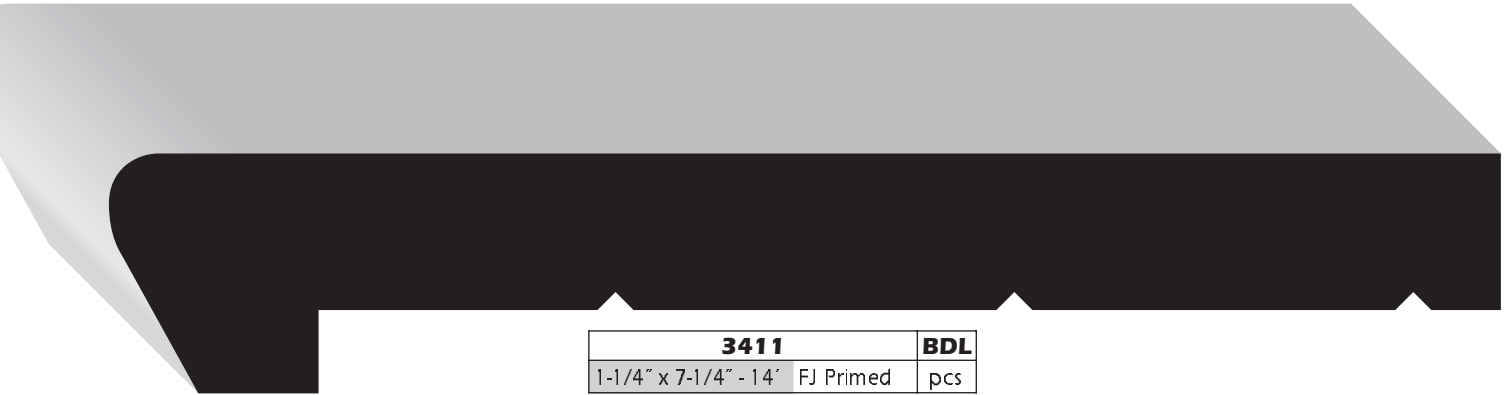

<b>3411</b>	<b>BDL</b>
1-1/4" x 7-1/4" - 14'	FJ Primed pcs

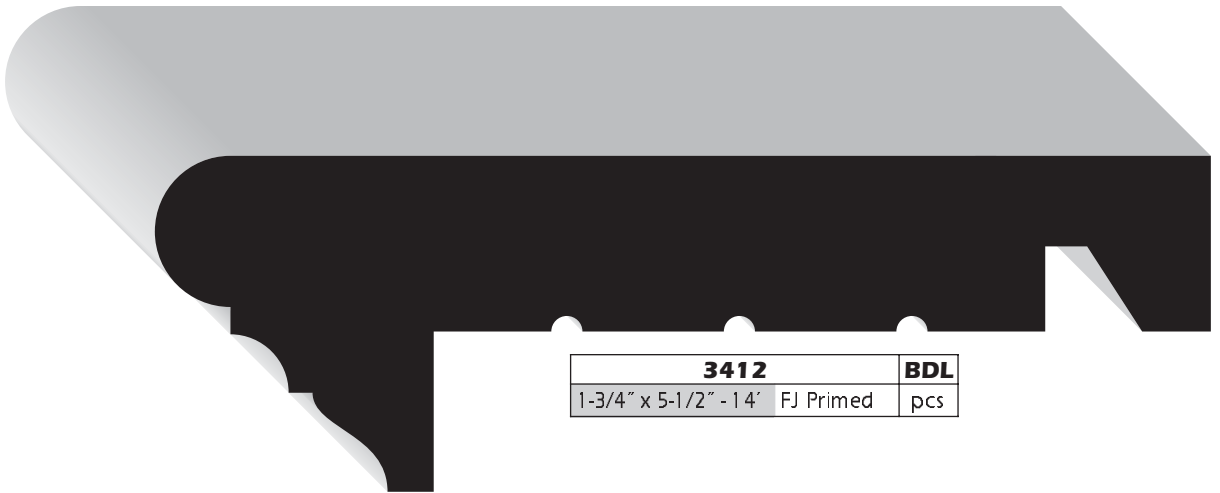

<b>3412</b>	<b>BDL</b>
1-3/4" x 5-1/2" - 14'	FJ Primed pcs

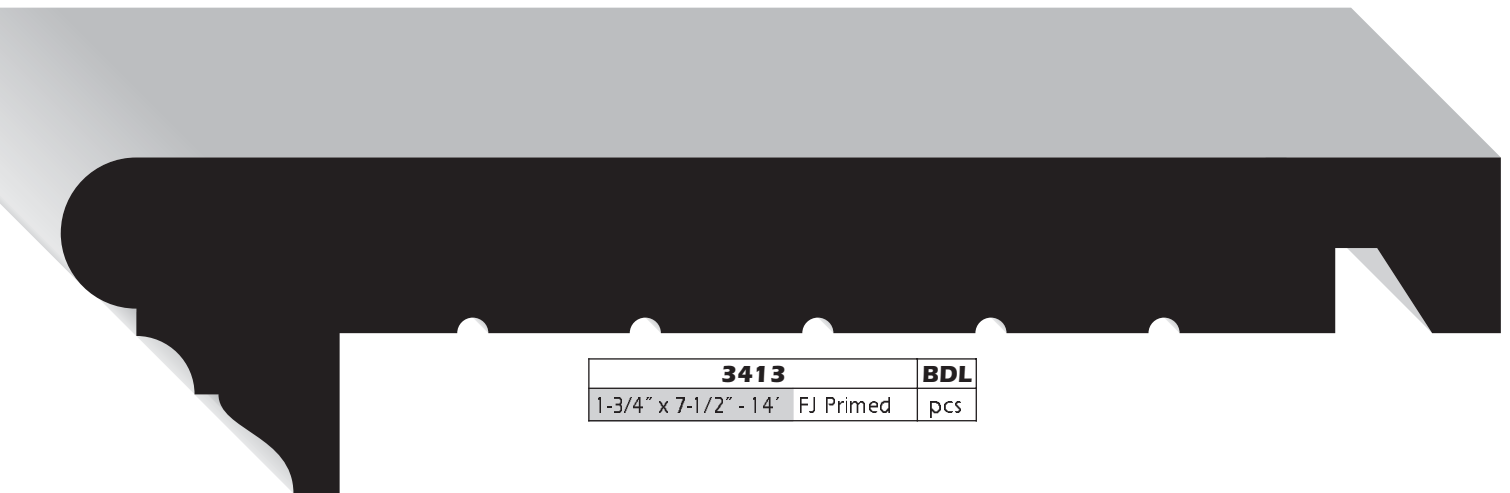

<b>3413</b>	<b>BDL</b>
1-3/4" x 7-1/2" - 14'	FJ Primed pcs

## Finish Lumber (S4S)

ALL SIZES NOMINAL



By Moulding & Millwork

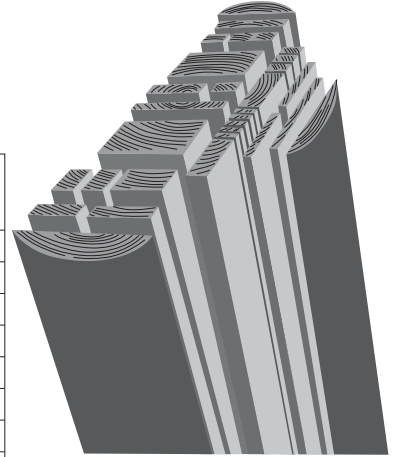

	1x2	1x3	1x4	1x5	1x6	1x7	1x8	1x10	1x12	2x2	2x3	2x4	2x6	2x8	2x10	2x12	4x4	1/2x2	1/2x3	1/2x4	1/2x5	1/2x6	1/2x8	
VG FIR	X	X	X	X	X		X	X	X		X	X	X	X	X	X		X	X	X	X	X	X	X
MG FIR	X	X	X	X	X		X	X	X	X	X	X	X	X	X	X	X		X	X	X	X	X	X
RED OAK	X	X	X	X	X		X	X	X	X		X	X											
FJ PRIMED	X	X	X	X	X	X	X																	
ULTRALITE	X	X	X	X	X	X	X	X	X															
VG HEMLOCK	X	X	X	X	X		X	X	X															
MAPLE	X	X	X	X	X		X																	
COMPOSITE PINE			X		X		X	X	X															

## Case/Base Combinations

**option 1**

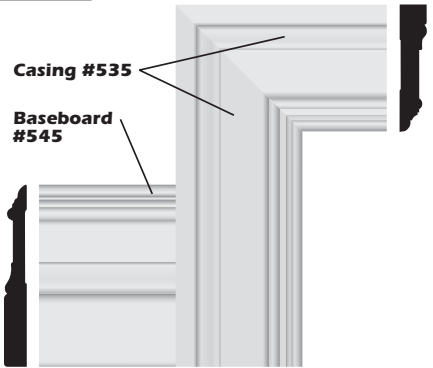

**option 2**

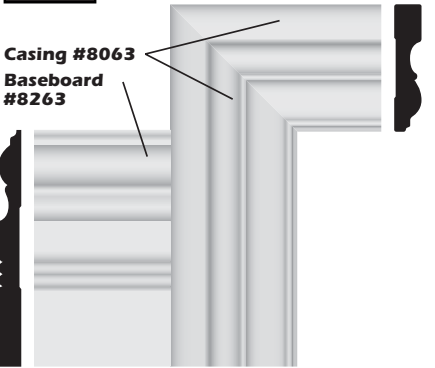

**option 3**

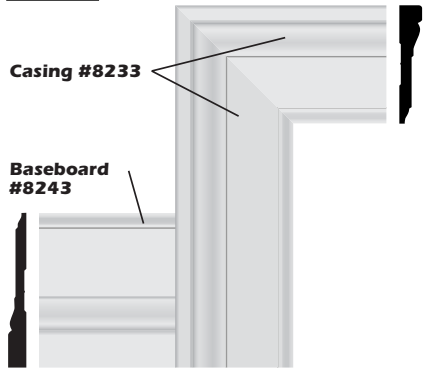

**option 4**

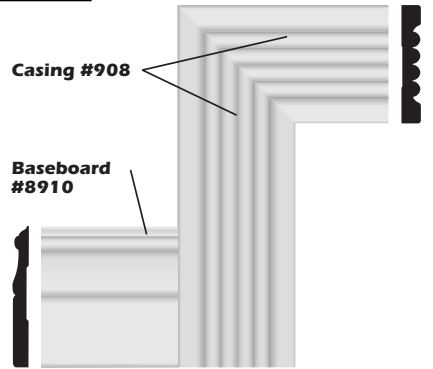

**option 5**

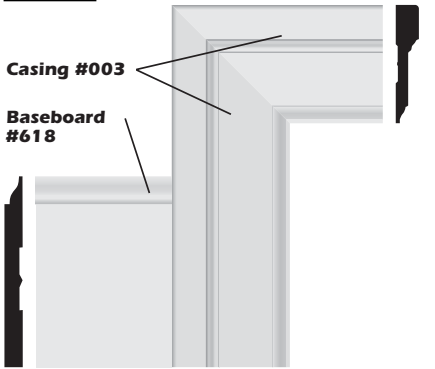

**option 6**

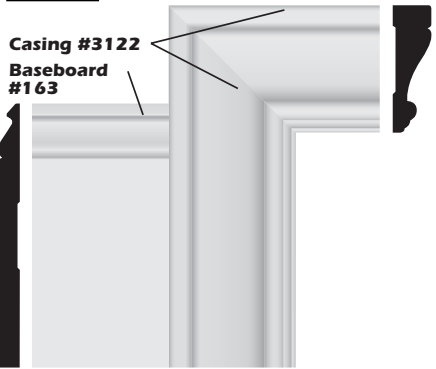

**option 7**

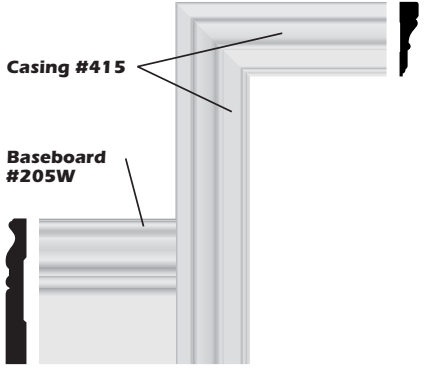

**option 8**

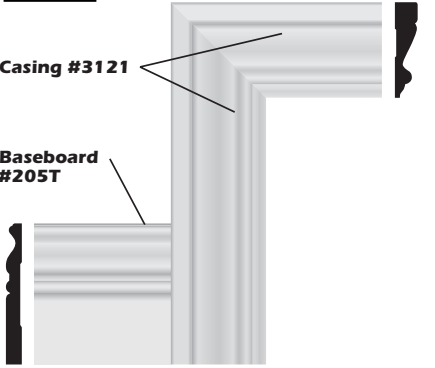

**option 9**

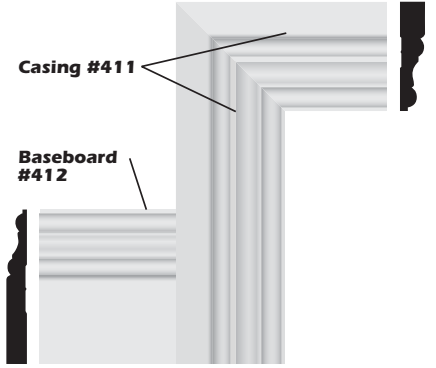

## Case/Base Combinations

### Family 1

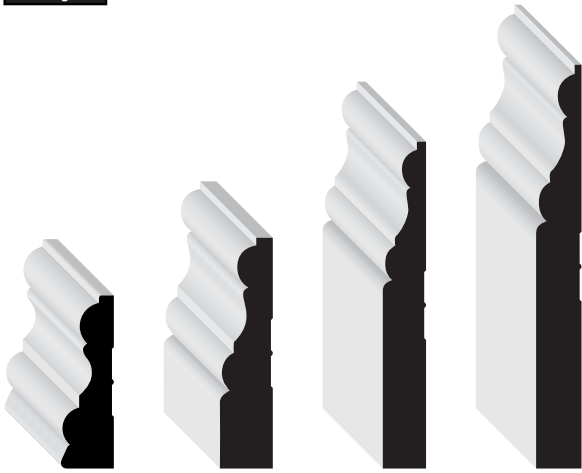

Casing  
410

Casing  
411

Baseboard  
412

Baseboard  
414

### Family 2



Casing  
1208

Baseboard  
653

Baseboard  
663

Baseboard  
673

### Family 3



Casing  
472

Casing  
492

Casing  
494

Baseboard  
3112

### Family 4



Casing  
3121

Casing  
3122

Baseboard  
205T

Baseboard  
205W

### Family 5

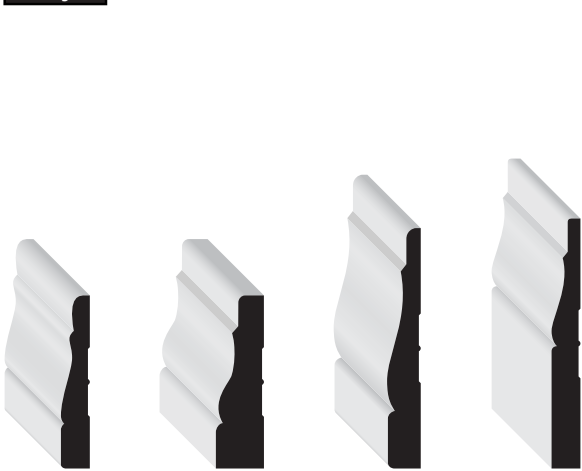

Casing  
356

Casing  
356 WM

Casing  
444

Baseboard  
3140

### Family 6



Casing  
8233

Casing  
003

Baseboard  
8243

Baseboard  
8234

## Ceiling Trim Options (Crowns)

**option 1**

Crown  
#54

Baseboard  
#653



**option 2**

Crown  
#51

Baseboard  
#205T

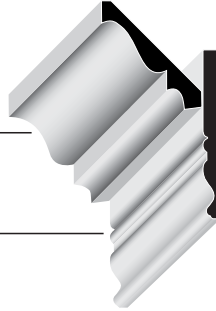

**option 3**

Crown  
#47

Baseboard  
#618



**option 4**

Crown  
#512

Casing  
#8234

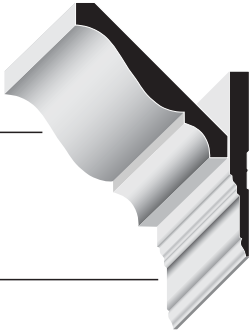

**option 5**

Crown  
#40

Baseboard  
#161



**option 6**

Crown  
#51

Baseboard  
#205T

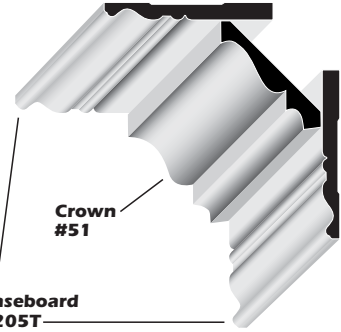

**option 7**

Crown  
#47

Baseboard  
#618

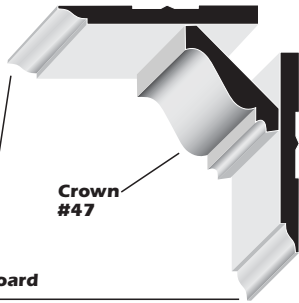

**option 8**

Crown  
#512

Baseboard  
#8234

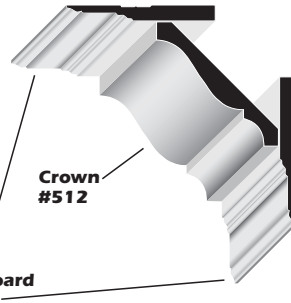

**option 9**

Crown  
#409

Baseboard  
#205T



**option 10**

Crown  
#3248

Baseboard  
#663



**option 11**

Crown  
#41

Baseboard  
#618

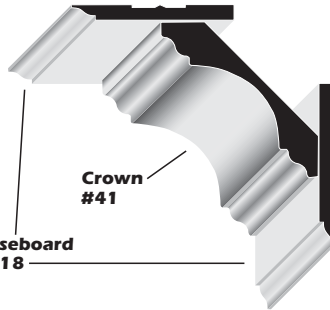

**option 12**

Crown  
#41

Baseboard  
#163



## Ceiling Trim Options (Crowns)

**option 13**

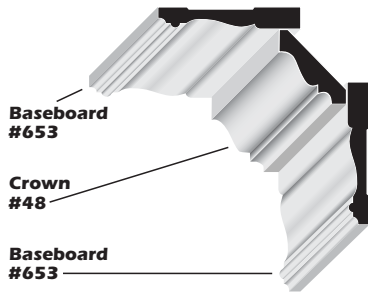

**option 14**

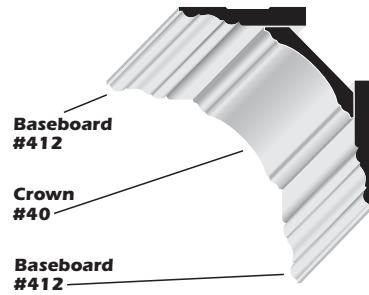

**option 15**

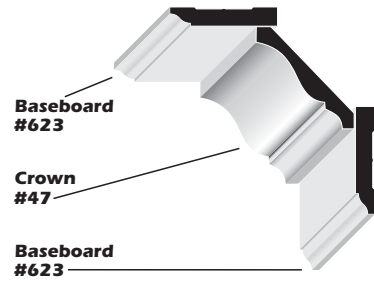

**option 16**

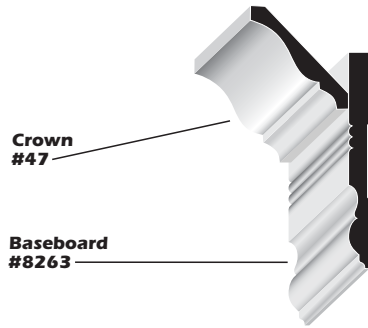

**option 17**

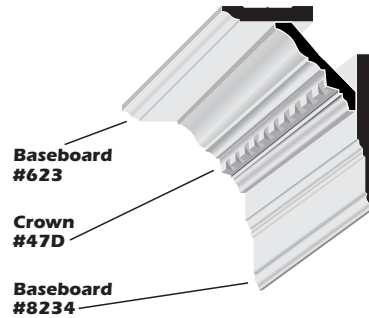

**option 18**

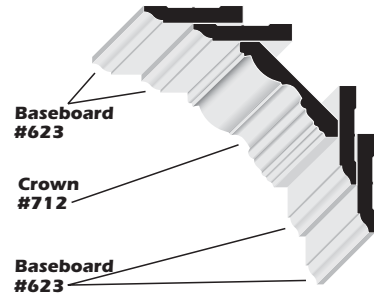

**option 19**

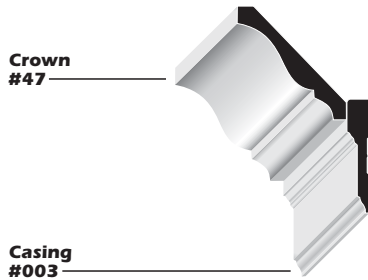

**option 20**

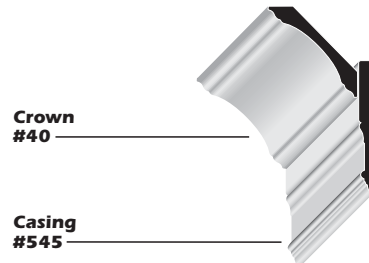

**option 21**

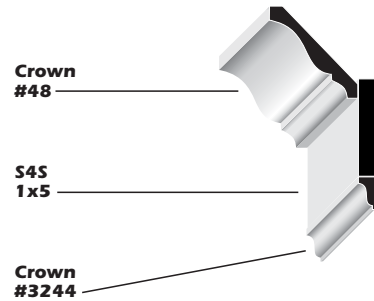

**option 22**

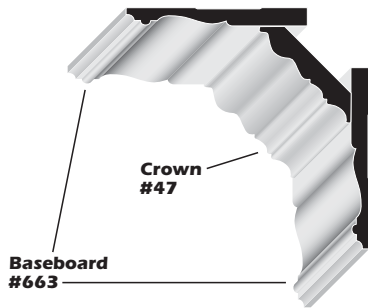

**option 23**

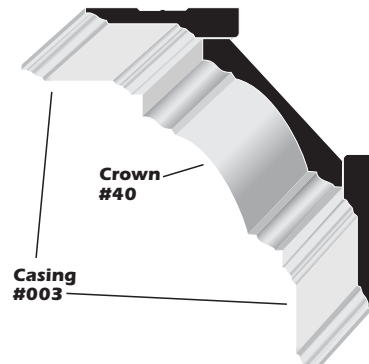

**option 24**

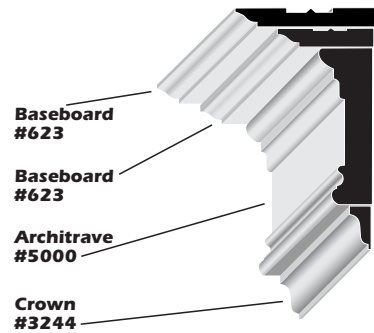

## Mantel Trim Options

**option 1**

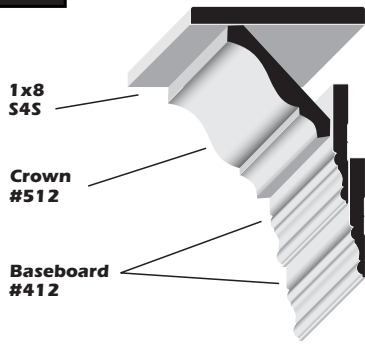

Paintable

**option 2**

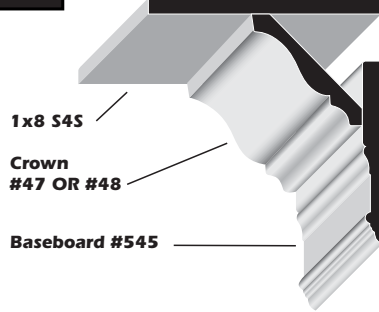

Paintable/Stainable

**option 3**

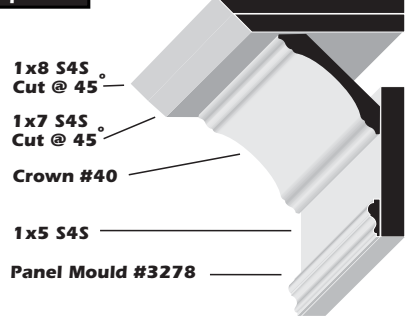

Paintable

**option 4**

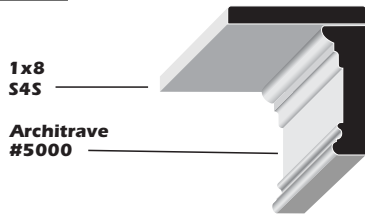

Paintable/Stainable

**option 5**

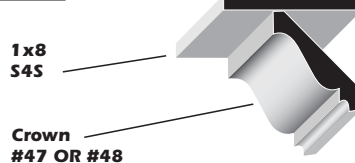

Paintable/Stainable

**option 6**

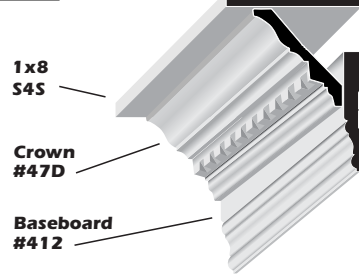

Paintable

**option 7**

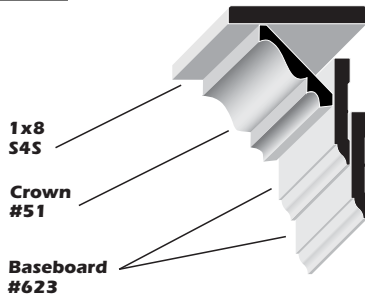

Paintable

**option 8**

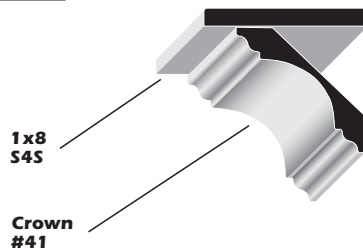

Paintable

**option 9**

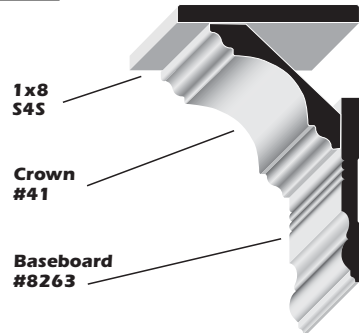

Paintable

**option 10**

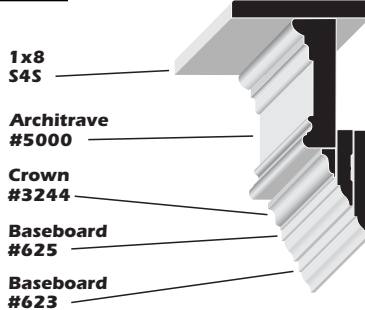

Paintable

**option 11**

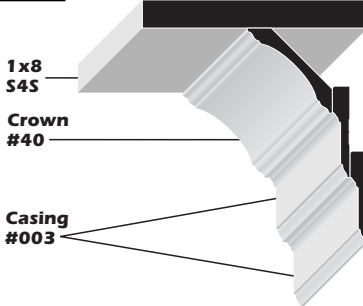

Paintable

**option 12**

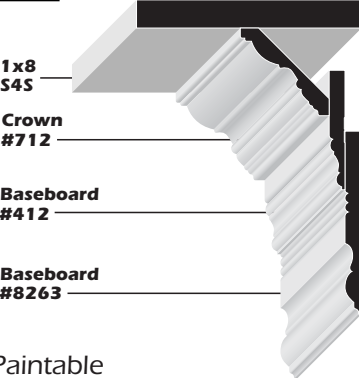

Paintable

## Door & Window Trim Options (Headers)

**option 1**

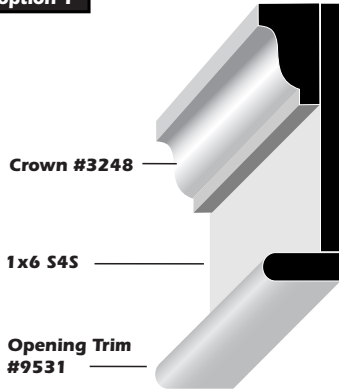

Crown #3248

1x6 S4S

Opening Trim #9531

Paintable/Stainable

**option 2**

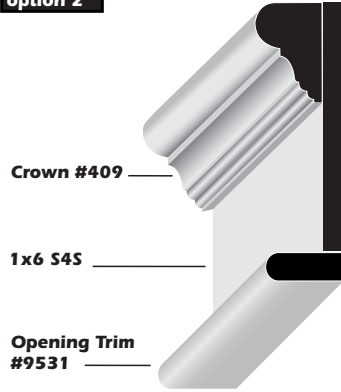

Crown #409

1x6 S4S

Opening Trim #9531

Paintable

**option 3**

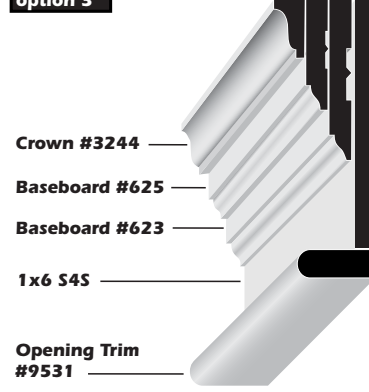

Crown #3244

Baseboard #625

Baseboard #623

1x6 S4S

Opening Trim #9531

Paintable

**option 4**

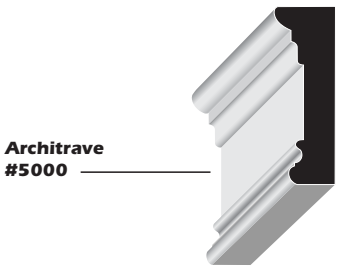

Architrave #5000

Paintable/Stainable

**option 5**



Architrave #5010

Paintable

**option 6**

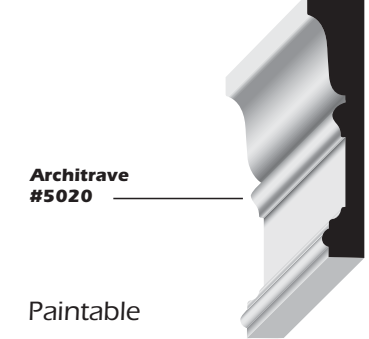

Architrave #5020

Paintable

**option 7**

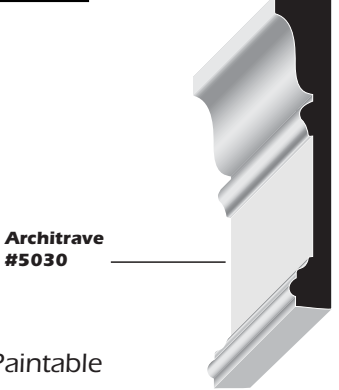

Architrave #5030

Paintable

**option 8**

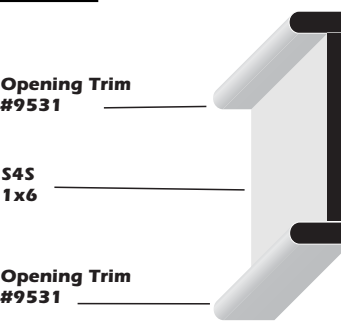

Opening Trim #9531

S4S 1x6

Opening Trim #9531

Paintable/Stainable

**option 9**

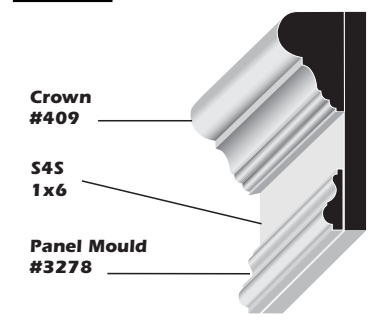

Crown #409

S4S 1x6

Panel Mould #3278

Paintable

**option 10**

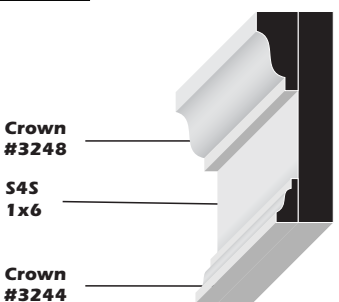

Crown #3248

S4S 1x6

Crown #3244

Paintable/Stainable

**option 11**

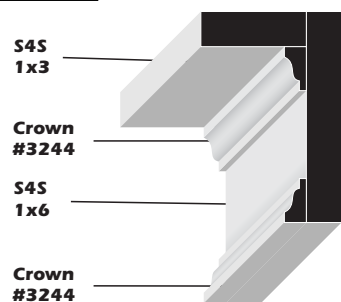

S4S 1x3

Crown #3244

S4S 1x6

Crown #3244

Paintable/Stainable

**option 12**

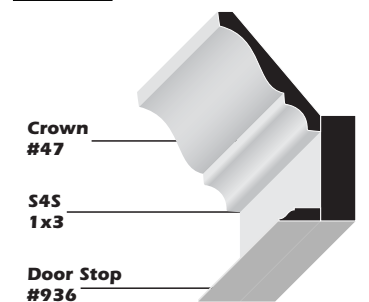

Crown #47

S4S 1x3

Door Stop #936

Paintable

## Wall Trim Options (Wainscot & Chair Rail)

**option 1**

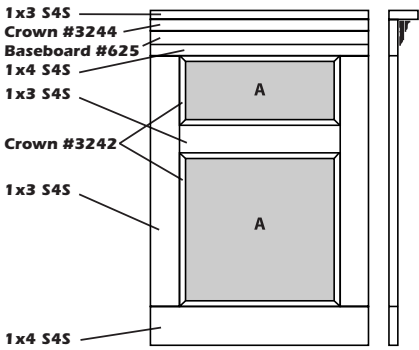

Paintable

**option 2**

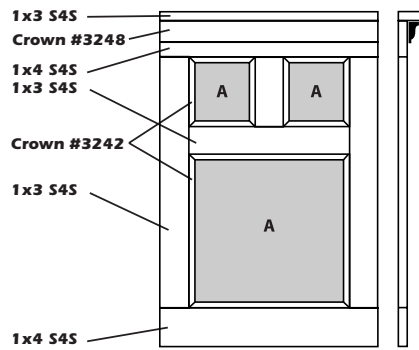

Paintable/Stainable

**option 3**

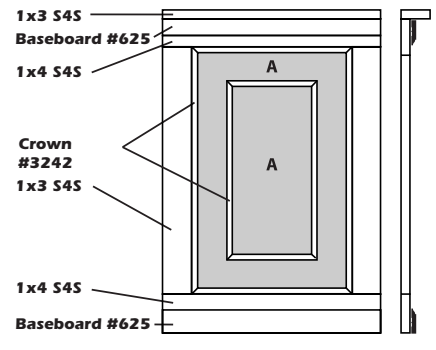

Paintable

A = Smooth wall could be contrasting color.

**option 4**

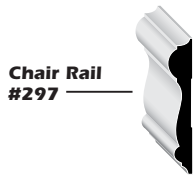

Paintable/Stainable

**option 5**

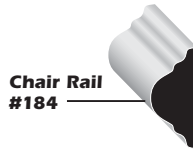

Paintable

**option 6**

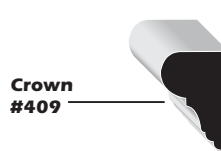

Paintable

**option 7**



Paintable/Stainable

**option 8**

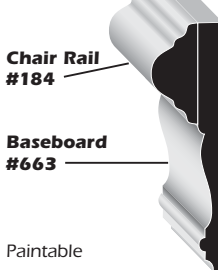

Paintable

**option 9**

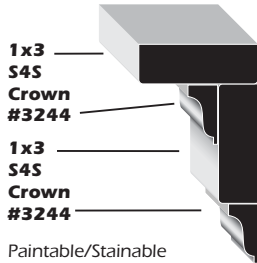

Paintable/Stainable

**option 10**

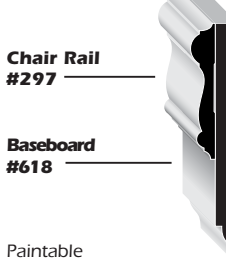

Paintable

**option 11**

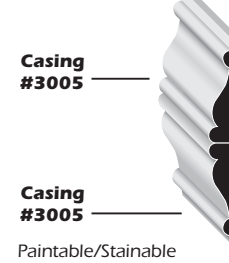

Paintable/Stainable

**option 12**

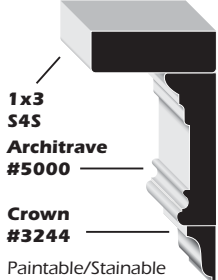

Paintable/Stainable

**option 13**

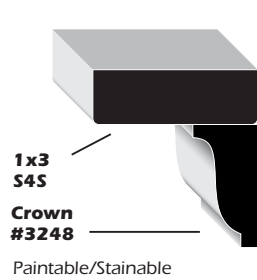

Paintable/Stainable

**option 14**

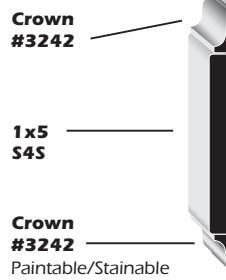

Paintable/Stainable

**option 15**

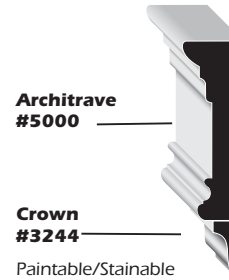

Paintable/Stainable

**option 16**

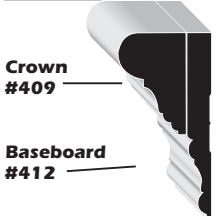

Paintable

**option 17**

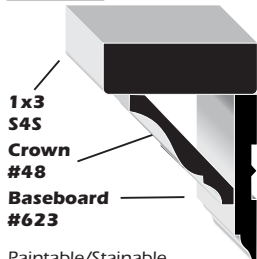

Paintable/Stainable

**option 18**

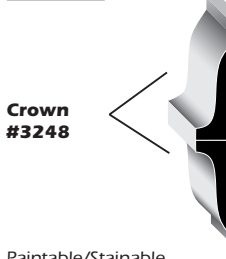

Paintable/Stainable

**option 19**

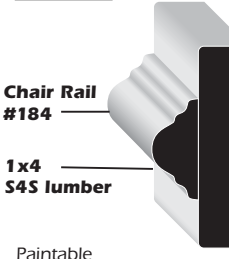

Paintable